



NAVY



RUGGED LCD MONITORS

M50 SERIES

17" RUGGED LCD MONITOR MS/MH 5117SX



Key Features

- MIL specs compliant
- Waterproof mount
- High brightness capability

Options

- Cold start at -20° C
- Resistive or capacitive touchscreen
- Touch input device
- Optical Bonding of the LCD panel

The **M50 Series Monitor Range** is the result of the best cutting-edge display technology combined with every functional, implementation and use constraints applied to the most demanding sectors of Defense and Industry.

Take the advantage of what the best of technology can bring to your Navy embedded IT systems requirements. Because you have a variety of use and operational needs, the IRTS M50 Series offers a comprehensive range of Monitors with several levels of protection, reinforcement and a wide choice of options (Power supply, connectors, touch input device, optical and electronic treatments...).

Our competitive prices ensure that you make the right investment whenever you buy a product at **IRTS**.

PRODUCT RANGE

MS and MH 5117SX 17" LCD monitors are part of the **M50 series**, a comprehensive range of displays described in the table below :



IRTS Monitors M50 Series								
MIL Specs Compliant M50 MCD Monitors Series								
Diagonal Sizes	17"	19"	20"1	21"3	24"	17"3	21"5	24"
Screen Ratios	5/4	5/4	4/3		16/10	16/9		
Resolutions	1280x1024 SXGA	1280x1024 SXGA	1600x1200 UXGA		1920x1200 WUXGA	1920x1080 FHD		
MS 50 series - Standard Brightness								
Brightness (cd/m ²)	300	300	250	400	300	330	250	250
Waterproof Panel Mount	MS 5117SX	MS 5019SX	MS 5020UX	MS 5221UX	MS 5224WU	MS 5117HD	MS 5221HD	MS 5224HD
19" Rack Mount	MS 5517SX	MS 5519SX	MS 5520UX					
MH 50 series - High Brightness								
Brightness (cd/m ²)	800	800	550			800	800	800
Waterproof Panel Mount	MH 5117SX	MH 5019SX	MH 5020UX			MH 5117HD	MH 5221HD	MH 5224HD
19" Rack Mount	MH 5517SX	MH 5519SX	MH 5520UX					

See also the other series of display panels in the 50 monitors' range specifically designed for Airborne (D50), Maritime & Industry (E50) applications.

PRODUCT CONFIGURATION

IRTS offers several configuration solutions according to environmental conditions and customer's needs.

Commercial reference		Standard Brightness M50 series MS5117SX
		High Brightness M50 series MH5117SX
Power Supply	0	12 VDC on HE308					
	3	90/264 VAC 50-400 Hz - 126/363 VDC on HE308					
	5	18-36 VDC on HE308					
Front Glass	ME	Antireflective Glass					
	MR	Resistive RS232 Touch Screen (with standard luminance loss of 20%)					
	MU	Resistive USB Touch Screen (with standard luminance loss of 20%)					
Input Video Connectors	2	Video: 2 x DVI-I					
	B	Video: DVI-D, RGB H/V, PIP : CVBS					
	S	Video: DVI-I, VGA HD15, PIP : CVBS & S-VHS					
Temperature Range	S	Standard Operating Range : 0° C to 55° C					
	E	Extended Operating Range : -20° C to 55° C					
Options	B	Bonding LCD Panel					
	V	Electronic Part Coating					



IRTS

639 Boulevard des Armaris ▪ 83100 Toulon ▪ France

Tel.: +33 (0)4 94 20 78 00 ▪ Fax : +33 (0)4 94 20 78 01

IRTS NATO CODE : FAAJ7

Contact : sales@irts.fr ▪ www.irts.fr

RUGGED ELECTRONICS, COMPUTERS & DISPLAYS

PRODUCT SPECIFICATIONS

Display Module 17" SXGA (1280 x 1024)		
	MS5117SX	MH5117SX
Brightness (user)	300 cd/m ² +/-10%	800 cd/m ² +/-10%
Active display area	337.920 mm x 270.336 mm	337.920 mm x 270.336 mm
Dot pitch	0.264 (H) x 0.264 (V) mm	0.264 (H) x 0.264 (V) mm
Viewing angles (LCD panel)	80°- 80° (H) / 60°- 80° (V)	80°- 80° (H) / 60°- 80° (V)
Response Time	30 ms (Tr+Tf)	30 ms (Tr+Tf)
Contrast Ratio (LCD Panel)	800 : 1	800 : 1
Display Color	16.7 M 8 bits	16.7 M 8 bits
Backlight	LED	LED
Dimming ratio	0 to 100%	0 to 100%
Controls		
"On Screen Display" (OSD)	Front waterproof 5-key keyboard	
Backlight brightness	Direct access by front waterproof 2-key keyboard	
Remote control	USB	
Physical Features		
Dimensions	8U : 431.8 x 354.8 x 81,5 mm (without removable handles)	
Weight	9 Kg +/- 10 %	
Packaging / color	Aluminum / Matt Black C3603 UB5-10 liquid paint	
Environmental conditions		
Operating temperature	0°C to +55°C (Cold Start -20°C Option), MIL-STD 810F, Method 501.4 & 502.4, Procedure II	
Storage temperature	-32°C to +70°C, MIL-STD 810F, Method 501.4 et 502.4, Procedure I	
Humidity	T=+40°C, HR = 5 to 95%, MIL-STD 810F, Method 507.4	
Salt fog	5 ±1% salt @35°C±2°C, MIL-STD 810F, Method 509.4, Procedure I	
Shock	30g - 11 msec Half sine - X,Y,Z axis	
Vibration	MIL-STD 167 Type I	
Random Vibration	up to 1g RMS, STANAG 4370 AECTP400 : Method 401 (Table 4), GAM EG13 C, DEF-STAN 0035 : TEST M1 (Figure A28)	
Sinus Vibration	up to 1.28g, MIL-STD 810G : Method 514.6 (Category 21) - Method 528	
Emission	Naval equipment: MIL-STD 461E: CE102 Basic Curve, RE102 Submarine application (internal to pressure hull) & RE 102 Surface Ship application (below deck)	
Susceptibility	Naval equipment: MIL-STD 461E: CS101, CS114, CS115, CS116, RS103, RE102 Army & Navy Mobile RE102 Surface Ship application (top side) on request	
Safety	CE Marking / IEC 60950	
Ingress protection	IP65 (front)	
Warranty		
Two-year limited warranty (parts and labor), factory return under RMA procedure.		
Additional 2 years coverage and customized service plans available on request.		



IRTS

639 Boulevard des Armaris ■ 83100 Toulon ■ France

Tel.: +33 (0)4 94 20 78 00 ■ Fax : +33 (0)4 94 20 78 01

IRTS NATO CODE : FAAJ7

Contact : sales@irts.fr ■ www.irts.fr

RUGGED ELECTRONICS, COMPUTERS & DISPLAYS

TECHNICAL LAYOUT

Dimensions are in millimeters (mm).

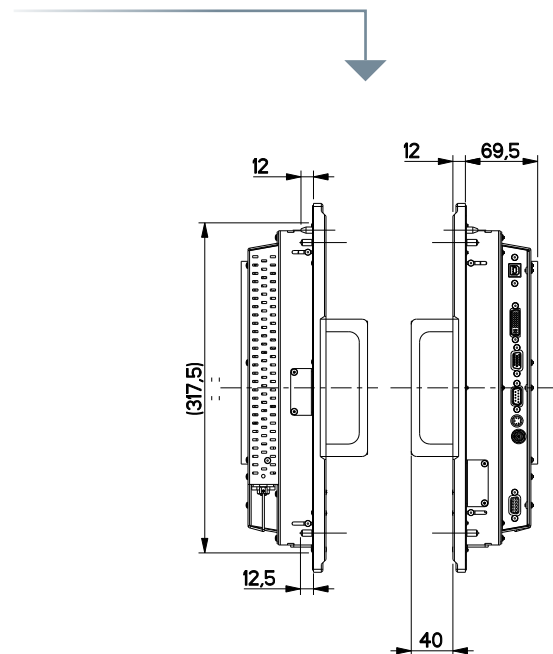
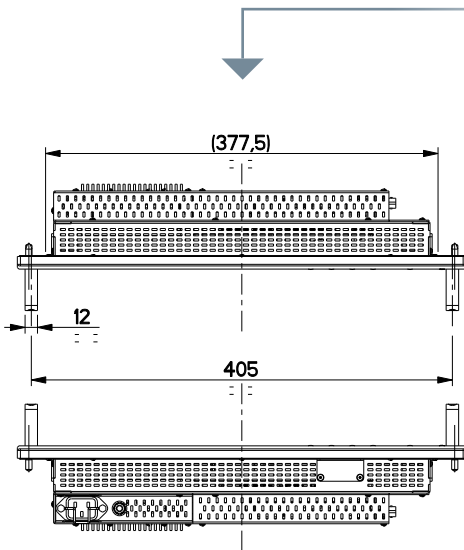
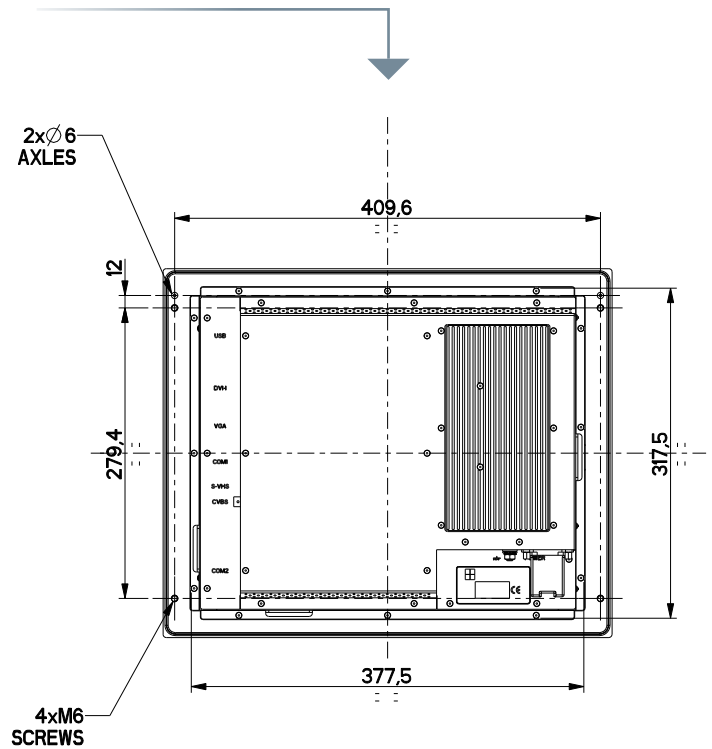
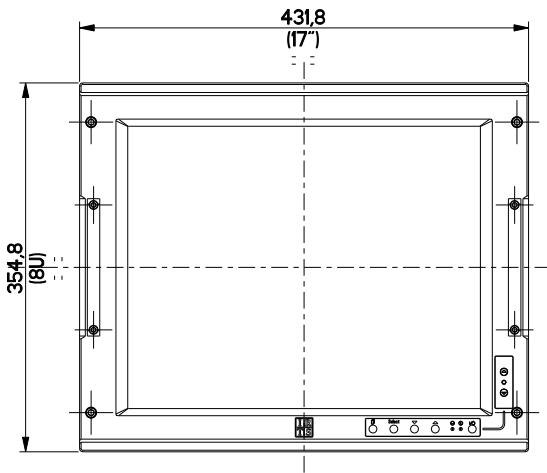

IRTS
 639 Boulevard des Armaris ■ 83100 Toulon ■ France
 Tel.: +33 (0)4 94 20 78 00 ■ Fax : +33 (0)4 94 20 78 01
 IRTS NATO CODE : FAAJ7
 Contact : sales@irts.fr ■ www.irts.fr

RUGGED ELECTRONICS, COMPUTERS & DISPLAYS